

# Kit 4028

DACIA Lodgy, 5-dr MPV, 12-

This kit is only for vehicles with flush or integrated side railing.



460R  
753

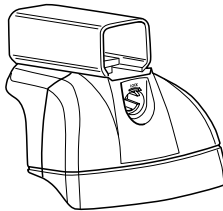

460

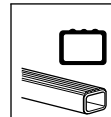

**Kit**



753

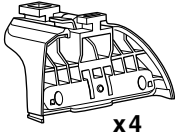

x4



x4



x4



16 mm

x8

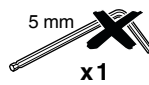

5 mm

x1



x4



x1

460R

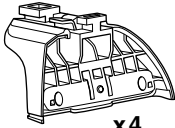

x4



x4



x4



16 mm

x8

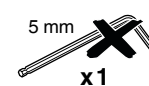

5 mm

x1



x4

460

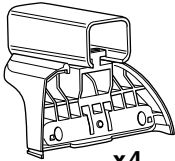

x4



x4



x4



16 mm

x8

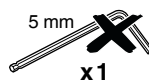

5 mm

x1



x4

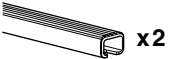
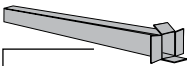

x2



x2

23 mm



x1

17 mm



x2

23 mm

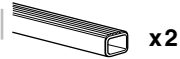

x2

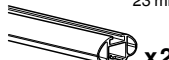

x2

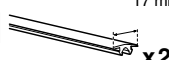

x2

23 mm

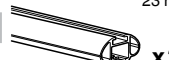

x2



x4

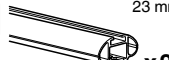

x2



x4



x4

1

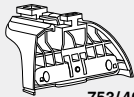

753/460R

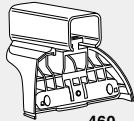

460

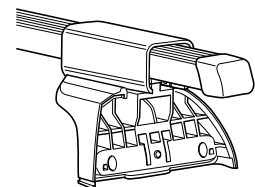
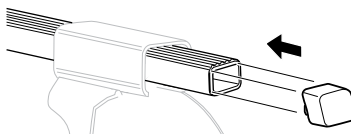
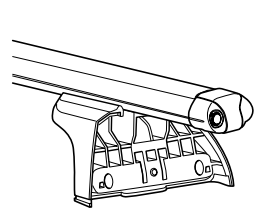
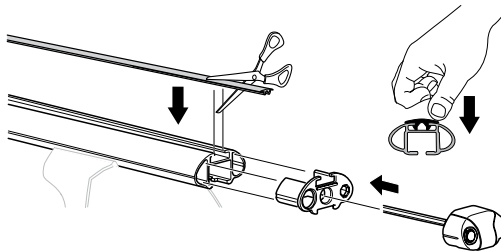
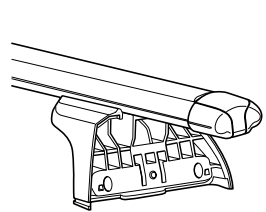
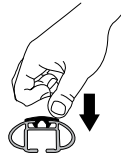
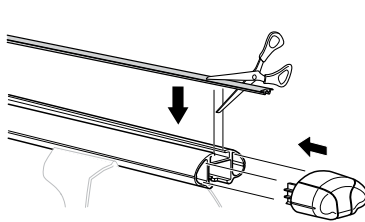
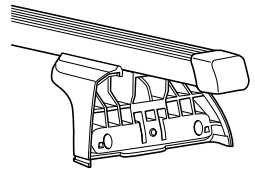
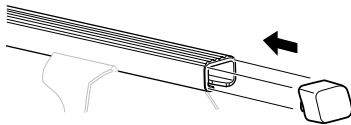
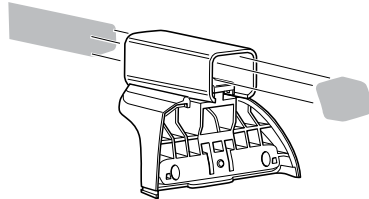
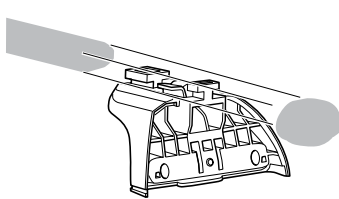

**2****x 4****i**

|            |                           |            |                                |            |                          |
|------------|---------------------------|------------|--------------------------------|------------|--------------------------|
| <b>GB</b>  | Only a few turns          | <b>EST</b> | Ainult mõni pööre              | <b>HR</b>  | Samo nekoliko okreta     |
| <b>D</b>   | Nur wenige Umdrehungen    | <b>LAT</b> | Tikai dažī apgriezieni         | <b>HU</b>  | Csak néhány fordítás     |
| <b>F</b>   | Quelques tours uniquement | <b>LIT</b> | Tik keli pasukimai             | <b>GR</b>  | Μόνο μερικές στροφές     |
| <b>NL</b>  | Slechts enkele slagen     | <b>PL</b>  | Wystarczy kilka obrotów        | <b>TR</b>  | Yalnız birkaç kez çevirm |
| <b>I</b>   | Solo qualche giro         | <b>RU</b>  | Достаточно нескольких оборотов | <b>中文</b>  | 只有几个转向                   |
| <b>E</b>   | Sólo algunas vueltas      | <b>CZ</b>  | Pouze několik otáček           | <b>한국어</b> | 두 세번만                    |
| <b>PT</b>  | Noções básicas            | <b>SK</b>  | Len niekoľko otáčok            | <b>日本語</b> | 数回転のみ                    |
| <b>S</b>   | Endast några varv         | <b>SLO</b> | Le nekaj obratov               | <b>ไทย</b> | หมุนเพียงไม่กี่รอบ       |
| <b>FIN</b> | Vain muutama kierros      |            |                                |            |                          |

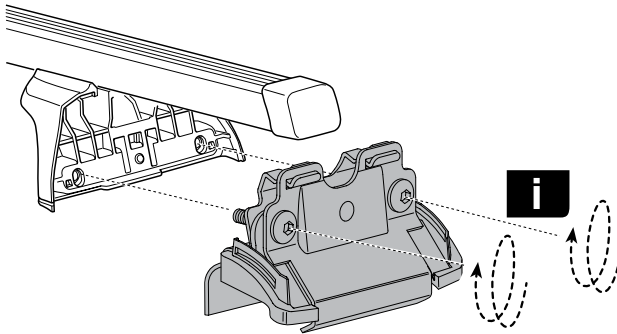
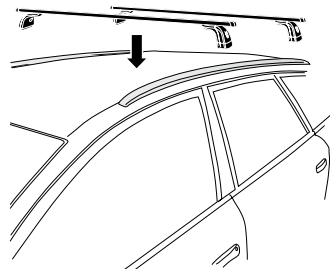
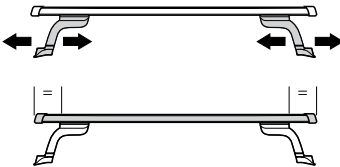
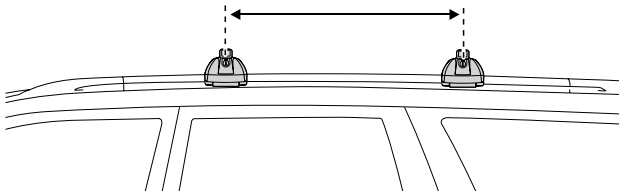
**3****~700 mm**

4

A

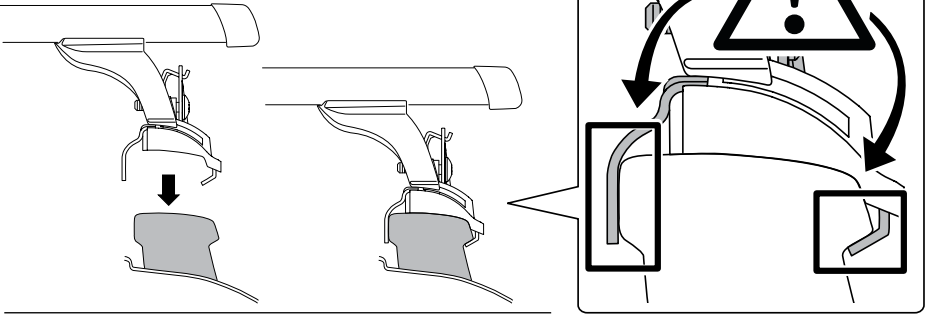

B

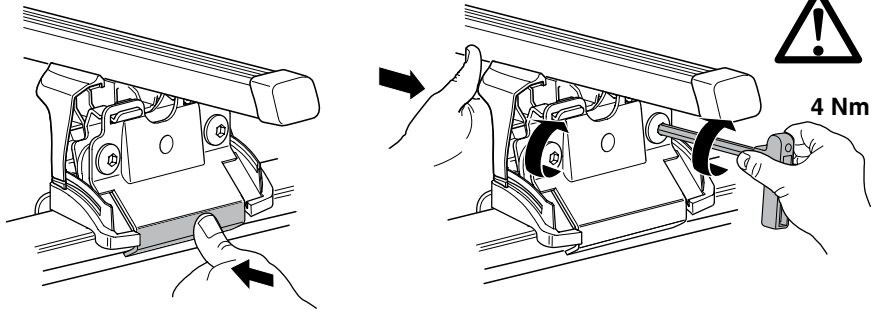
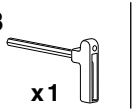

GB/US

Tighten alternately

D

Die Schrauben abwechselnd anziehen

F

Serrer alternativement chaque côté

NL

Afwisselend aan de linker- en de rechterkant aandraaien

I

Alternare il serraggio delle viti

E

Apretar alternativamente

PT

Aperte alternadamente

S

Dra åt växelvis

FIN

Kierrä vuorotellen

EST

Pinguldage vaheldumisi

LAT

Pievēlciēt pamišus

LIT

Užsukinėkite pakaitomis

PL

Śruby dokręcaj naprzemiennie

RU

Затягивайте попеременно

CZ

Pokręťta багаžníka dokręcaj dokręcaj naprzemiennie.

SK

Dotahujte striedavo

SLO

Privijajte izmenično.

HR

Naizmjenično zategnite

HU

Egymástól függetlenül szorítandó

GR

Σφιγγετε εναλλάξ

TR

Dönüşümlü sıkın

中文

交替拧紧

한국어

번갈아 가며 조이십시오.

日本語

交互に締め付けてください。

ไทย

ขึ้นในแบบสลับ



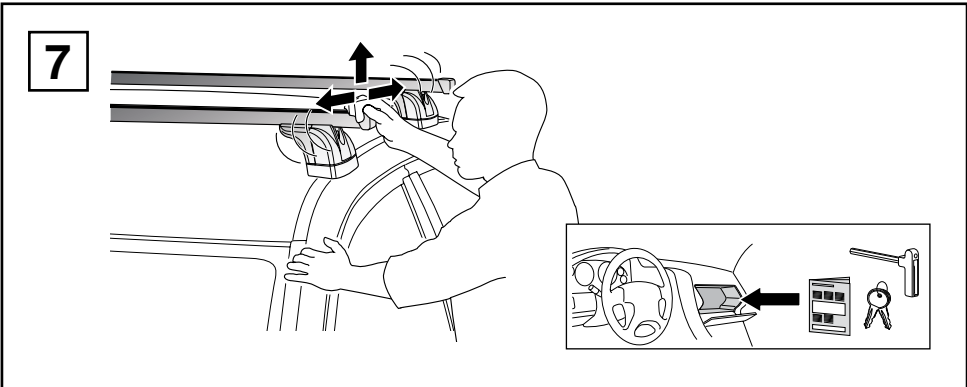
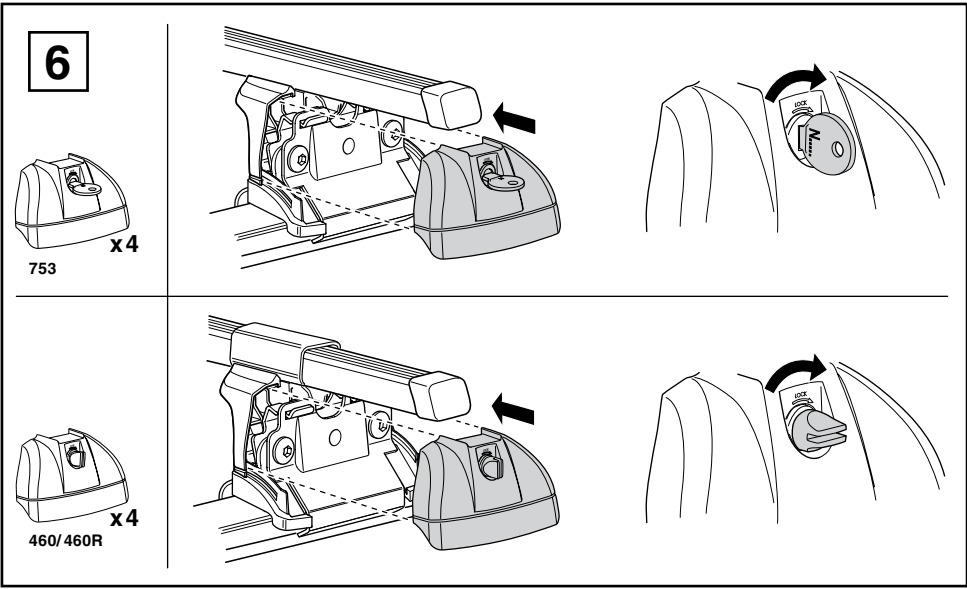
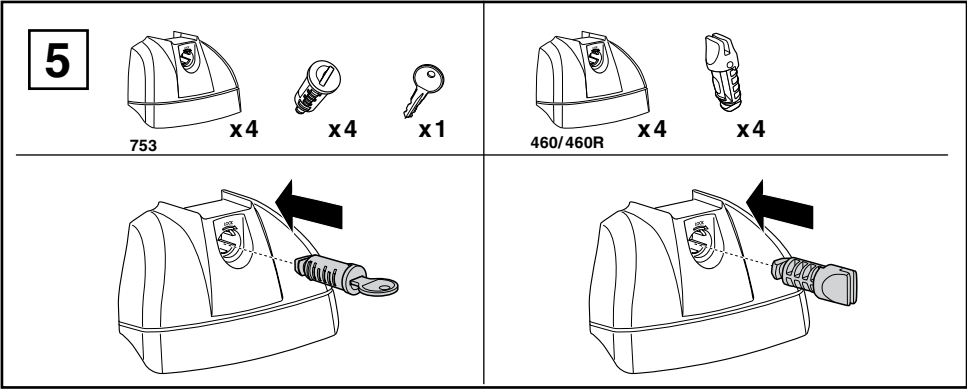

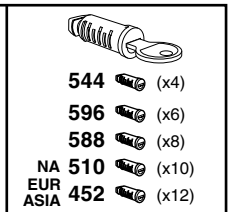
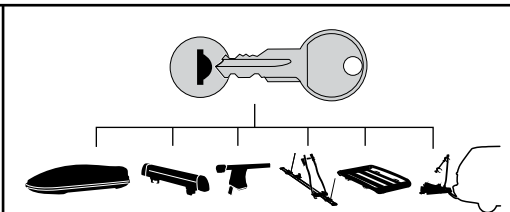
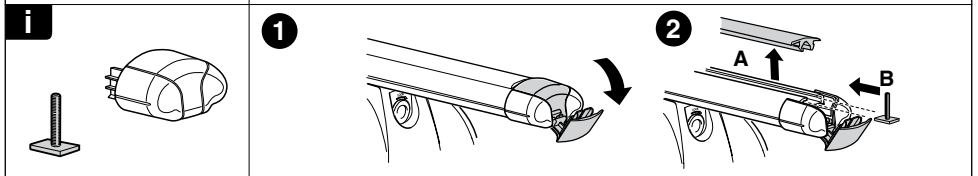
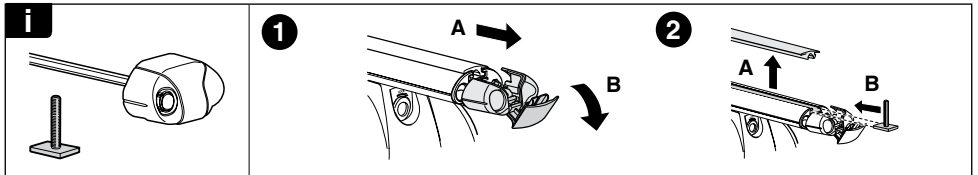
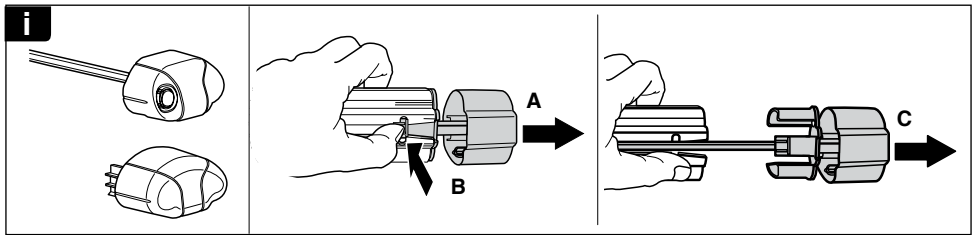
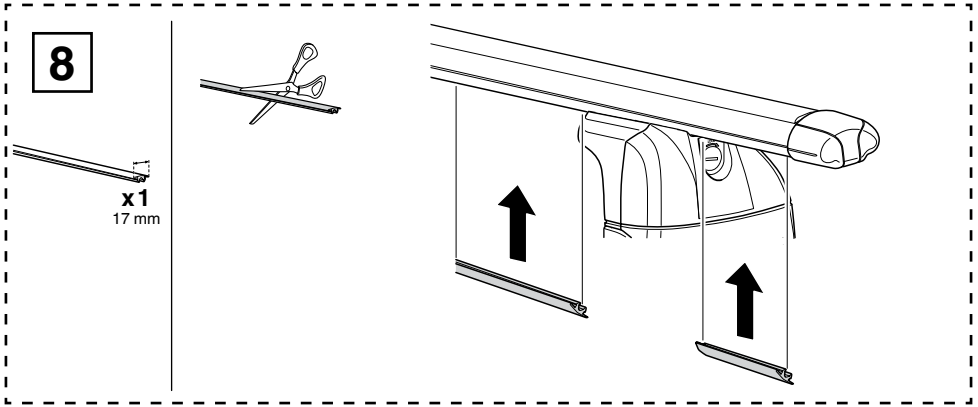

WW ▶ Thule Sweden AB, Box 69, 330 33 Hillerstorp, SWEDEN  
 NA ▶ Thule Inc., 42 Silvermine Road, Seymour, Connecticut 06483, USA

info@thule.com  
 customer.service@thule.com

www.thule.com